



Led Illuminator and Light Stimulator

Model # **LSD-1**
Including Optopatcher™ instructions

Ver. 2.1.0
2.18



Information in this document is subject to change without notice.

No part of this document may be reproduced or transmitted without the express written permission of ALA Scientific Instruments Inc.

While every precaution has been taken in the preparation of this document, the publisher and the author assume no responsibility for errors or omissions, or for damages resulting from the use of information contained in this document. In no event shall the publisher and the author be liable for any loss of profit or any other commercial damage caused or alleged to have been caused directly or indirectly by this document.

© 2016 ALA Scientific Instruments, Inc. All rights reserved. Printed: Feb. 2018

ALA Scientific Instruments, Inc.

60 Marine Street

Farmingdale, NY 11735

Phone: +1 631.393.6401

Fax: +1 631.393.6407

sales@alascience.com

www.alascience.com

Table of Contents:	Page #
SAFETY	1
1.0 INTRODUCTION	2
2.0 LSD-1 CONTROLLER	2
2.1 Top Panel	3
2.2 Side Panel	3
3.0 LIGHT GUIDE INSTALLATION	4
3.1 Standard 5mm Light Guides	4
3.2 Optogenetics Light Guide	4
3.2.1 Light guide positioning	5
4.0 LED MODULE REPLACEMENT	6
5.0 LSD-1 MODES OF OPERATION	7
5.1.0 Analog Command Button	7
5.1.1 Manual Mode (Analog Command Disabled)	7
5.1.2 Voltage Command Mode	7
5.1.3 FLASH LAMP MODE	7
6.0 OPTOPATCHER™	7
7.0 SPECIFICATIONS	10
8.0 WARRANTY	10

Safety

Wear protective eyewear when operating this device.

Do not use the device in a manner which is inconsistent with its intended function.

Do not expose the device to extreme conditions of humidity, hot or cold.

Do not use in a wet area or allow the power supply to become wet or submerged.

Do not use if wires are damaged or conductors are exposed.

This device has no clinical application and may not be used with human subjects at all.

1.0 Introduction

Optogenetics is a biological technique which involves the use of light to control cells in living tissue, typically neurons, that have been genetically modified to express light-sensitive ion channels or are naturally able to be stimulated with light. .

2.0 LSD-1 Controller

The LSD-1 uses a single LED to enable the application of a narrow wavelength of light for use as illumination or stimulation of a sample or biological preparation. Using a liquid light guide, or fiber optic cable, the LSD's output can be aimed at a sample on a microscope stage for field illumination to reveal photofluors or other luminescent substances. The light guide can also be introduced to microscope optics by connection to an appropriate port on a microscope to provide field illumination. The LSD is also used to provide light for the Optopatcher™ which allows for the stimulation via light of a cell under study with a patch clamp electrode.

The intensity of the LED can be controlled manually by a dial on the top, or an analog signal can be connected to the side BNC to provide computer control of the intensity and on/off of the LED via data acquisition system. Also, a TTL signal can be used to create a Flash Lamp whereby the LED flashes at 1.5X normal brightness for the duration of the TTL signal, but should not exceed 4msec.

If necessary, the LED can be changed to another wavelength via a simple procedure.

2.1 Top Panel



- A. Light Output: Adapter for light guides. Standard adapter is for a 5mm liquid or fiber optic light guide. An optional adapter and ferrule for the Optopatcher are available.
- B. Intensity: Knob to adjust light intensity. Clockwise increases intensity.
- C. Analog Command: Enable/Disable manual mode, analog voltage control mode or Flash Lamp mode.

2.2 Side Panel



- A. Power In: DC power port for universal supply (6v @ 2A).
- B. Fuse Holder: LSD controller fuse (2A 5x20mm fuse).
- C. Power: Switch to turn power ON/OFF to LSD controller.
- D. Analog Input: BNC connector to input an analog voltage command (0-5Vdc).

3.0 Light Guide Installation

3.1 Standard 5mm Light Guides



The standard LSD-1 system comes with an adapter for 5mm liquid or fiber optic light guides.

Insert the end of the light guide into the adapter. Adjust the depth of insertion for maximum LED output. Using a 0.050" Allen key, tighten the set screw to secure the light guide in place.

3.2 Optogenetics Light Guide

The LSD-1 can be used for Optogenetics research. The system can be purchased with optional adapter and ferrule for use with the Optopatcher light guide.

The optopatcher light guide is only 200um in diameter. It is important to make sure that it is centered over the LED within the LSD chassis.



The Optopatcher light guide requires a ferrule to hold and protect the input end of the fiber optic that will reside within the LSD. The Ferrule holds the end of the fiber optic cable and allows it to be adjusted in the best possible position to receive the maximum amount of light.

Use a 0.035" Allen key to secure the fiber optic cable to the ferrule.



Insert ferrule into light guide mount. Make sure ferrule is flat on top of light guide mount. The mount has three set screws allowing the position of the fiber to be optimized over the LED.

This alignment is done at the factory when a complete system is purchased. Only the bottom set screw (indicated by black dot) should be loosened or tightened to maintain alignment.



With the ferrule fully inserted, tighten the bottom set screw only using a 0.050" Allen key.

3.2.1 Light guide positioning

LEDs can vary in thickness. In order for the LSD to emit the highest amount of light possible, the 200um fiber optic of the Optopatcher and the LED must be in very close proximity. They should not touch, but only about 1mm of space should separate them. This gap is set at the factory, but when changing LEDs the gap may need to be adjusted.

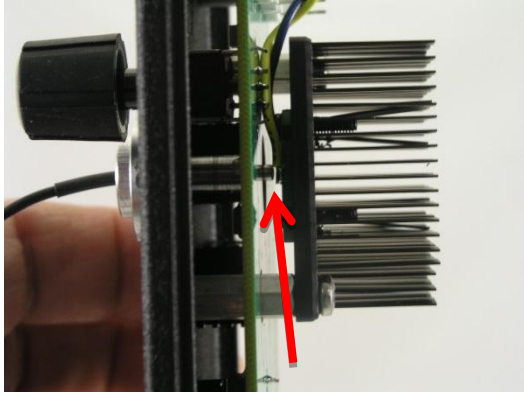

Observe that the gap between the LED and the Fiber Optic Ferrule should only be about 1mm.

The fiber should never touch the LED.

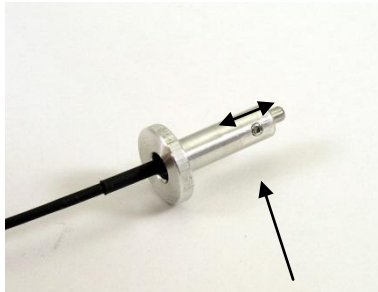

To adjust the position of the fiber optic end, loosen the set screw using a 0.035" Allen key and slide to the correct position and then tighten.



If the X-Y orientation of the fiber optic needs to be adjusted after an LED change; use the three set screws on adapter to adjust the position.

Always make sure the ferrule is flat against the top of the adapter. For best results, put the other end of the fiber optic into a light meter, turn the LSD intensity to maximum and slide the ferrule in the fiber holder until the highest power is achieved on the light meter. Lock the ferrule in this position with the three set screws using a 0.050" Allen key.

Alternatively, project the output of the fiber optic onto a white surface and observe the brightness as you adjust positioning of the ferrule.

4.0 LED Module Replacement

The LSD system can use different wavelength LED's. Optional LED modules can be installed in the LSD when a different wavelength (color) is required. Wavelength is indicated on to module. The following steps are required to change the LED module.

- Remove screw on each corner of the top of the LSD controller.
- Lift the top off the controller.
- Disconnect the LED module from the main circuit board labeled (J2).
- Remove two (2) screws (arrows) from top holding the LED module to the top.
- Place new LED module in place and secure two top screws.
- Connect LED module leads to main board (J2)



Since there are many different LEDs on the market and they often have different power requirements, the LSD has been designed to allow three different power settings to accommodate more types of LEDs. These are designated with the power settings Low, Medium, and High.

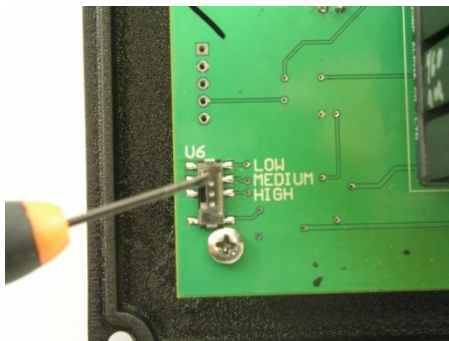

The correct power setting for an LED is set using the small slide switch on the circuit board adjacent to the heat sink.

All LEDs will come with a power designation (Low , Medium, High power) as well as the wavelength written on their assembly as indicated below.

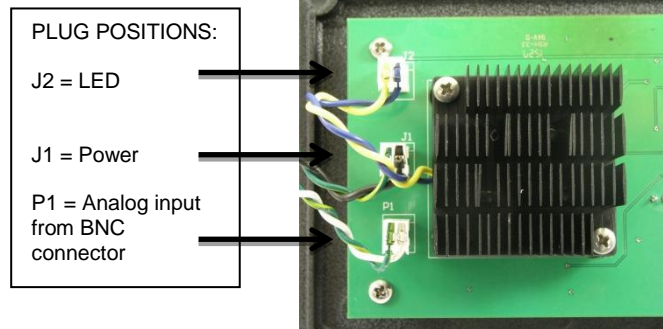

Note the "LOW" and "MED" written on the LED heat sink. This indicates that the power level that must be selected on the slid switch to use this LED.

NOTE: Failure to select the correct power mode will damage the LED's and the LSD electronics and void the warranty.

5.0 LSD-1 Modes of Operation

5.1.0 Analog Command Button

The LSD-1 is designed to function in 3 modes depending on experimental requirements. The LSD-1 controller can be used in manual mode, voltage command mode or flash lamp mode.

5.1.1 Manual Mode (Analog Command Disabled)

When the Analog Command light is not illuminated, the unit is in manual control mode. The user can change the light brightness output of the light by turning the intensity knob. Turning the knob clockwise will increase the intensity.

5.1.2 Voltage Command Mode

Pressing the Analog Command button once will enable the analog voltage mode. This is indicated by a steady green light. Use the analog input BNC on the side of the controller to apply a voltage from 0 to 5 V dc. The user can control the on/off and intensity of the light with 5V being maximum power.

5.1.3 Flash Lamp Mode

Pressing the Analog Command button until the green indicator light flashes will enable the Flash Lamp mode. In this mode a 5V TTL signal at the Analog Input BNC will cause the LED to "Flash". The duration of the flash is set by the length of the TTL high signal.

Caution: *The flash must be limited to 4msec or the LED may be damaged and void the warranty.*

The minimum flash time is 50usec and there will be a 25usec delay, which for example, would give a total flash time of 30usec for a 50usec, 5V command pulse. The Maximum duty cycle cannot exceed 50% or the LED will be damaged. The flash power will be +50% of normal highest intensity.

6.0 Optopatcher TM

Please note: *Beginning in late 2017, Optopatchers from ALA Scientific Instruments come with a single fiber optic that goes from the light source to the tip of the pipette. ALA discontinued supplying the ceramic ferrule and additional fiber mounted in the pipette holder. This change, where one fiber with no interruption is used to carry the light signal to the pipette tip resulted in a significant power boost at the pipette tip.*

Installation: The fiber optic is threaded into the 30° port of the pipette holder. A single fiber, with no breaks, goes directly from the LED to the tip of the recording pipette. This transfers the maximum amount of light energy possible. (See installation on You Tube: <https://youtu.be/qEMI-ut2luo>)

Fiber optic strand

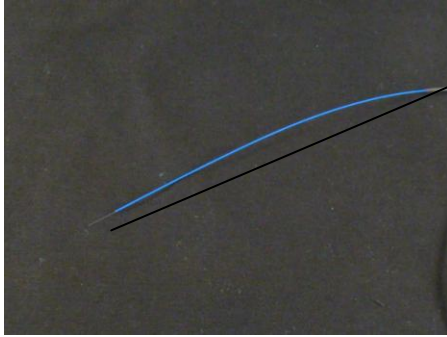

Bare fiber, about 2cm at the end of blue jacket, will go into the pipette with part of the blue jacket section as well.

The fiber is unprotected at this point. The user should be careful not to scratch the surface.

Fiber is inserted into pipette holder

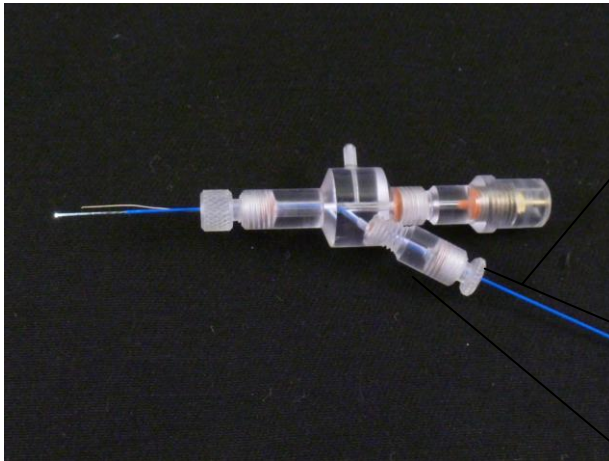

Fiber optic is inserted into pipette holder from the 30° port. There are two o-ring seals, you must loosen the outer nut, and then the shaft to open the seals. Also loosen the pipette holding seal.

Outer nut

Shaft—gently twist open

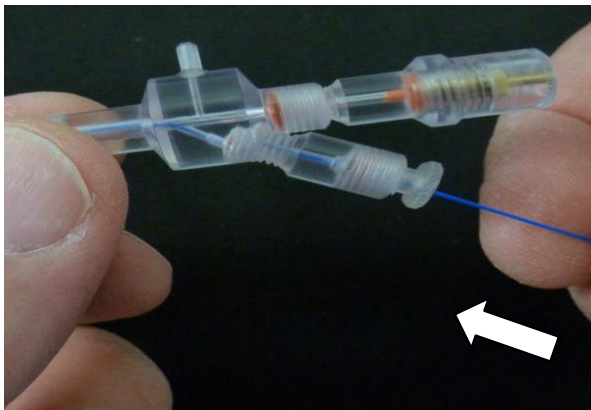

Once the seals are loose, gently slide the fiber into the pipette holder, the fiber will conform to the 30° bend, push it until it emerges from the front of the pipette holder. Gently tighten the two seals to hold the fiber in place.

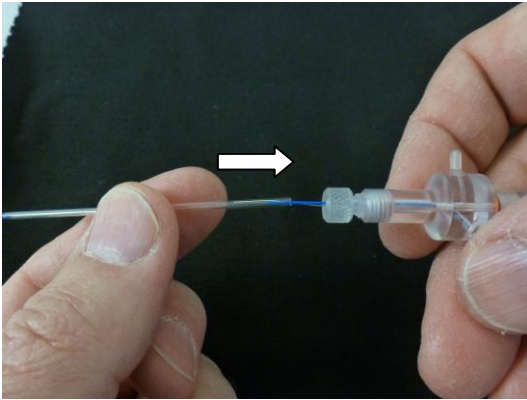

Place the pipette over the end of the fiber and the silver wire.

NOTE: It is very important to polish the back end of the patch pipette so that the glass does not nick or scratch the outer coating of the bare part of the fiber optic.

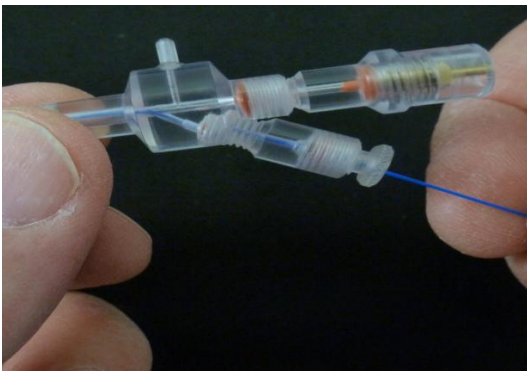

Slide the pipette into the holder, then tighten the nut to secure the pipette once the back of the pipette is at least past the seal--but not past the suction port.

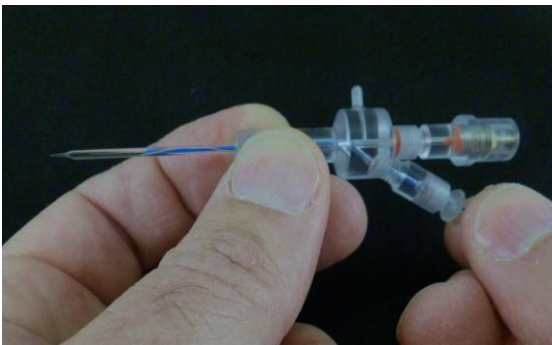

Observe the tip of the fiber and slide it into the tip of the pipette but not to the point where it blocks off the lumen of the pipette from the rest of the saline in the pipette. If this happens the patch signal may be diminished.

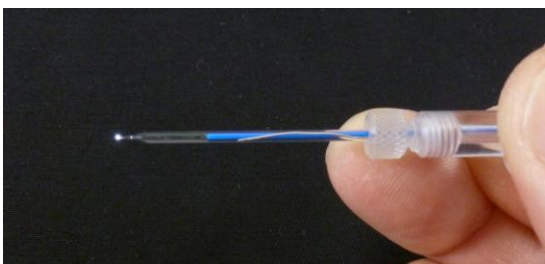

Be sure to tighten all seals to secure the pipette and the fiber to be sure your pipette can make a good seal.

The refractive index of the liquid in the pipette will help focus the light at the tip, the closer the fiber end is to the tip of the pipette, the more light energy will be focused there since some energy may be lost to the liquid.

In the event that your fiber breaks, you can cut it to form a new tip. A nick should be made on the side of the bare fiber with a diamond tool and the fiber cleaved like glass. Do not cut with scissors or a wire cutter, this will deform the tip and reduce the light emission.

7.0 Specifications

Universal AC adapter	Input 100 – 240 VAC 50/60 Hz Output 6 VDC @ 2.5 A max output
Power Fuse (5 x 20 mm)	2.0 A Fast Blow 250V
Analog voltage input	0 – 5 VDC
Temperature Range	0°C to 65°C
Enclosure (W x H x D)	13.2 x 9.4 x 8.1 cm (5.20 x 3.7 x 3.2 in)
Enclosure Weight	0.36 kg (0.8 Lbs.)

8.0 Warranty

ALA Scientific Instruments, Inc. agrees to warranty this product against defects in material and workmanship for one year from date of shipment. Remedy shall be limited to replacement or repair of the item(s) at ALA's discretion. The usage of this product by the user will indicate the users understanding of the use of this product as set forth in this manual. Neither ALA Scientific Instruments, Inc., nor any of its affiliates will be held responsible for damage to laboratory equipment, including microscopes, resulting from the use or misuse of this product, including damage resulting from inputs exceeding specified limits that result in malfunction to or from this device. The user asserts that he/she is aware of the electrical output and that he/she will insure that it does not exceed manufacturers' recommendation.

In the event that warranty repairs are necessary, shipping charges to the factory are the customer's responsibility. Return charges will be paid by ALA Scientific Instruments for warranty repairs only.

This instrument is not for clinical use. It is strictly for basic research in a laboratory setting. It has no clinical application whatsoever and cannot be used on human subjects.

Email: Support@alascience.com
Voice: 631 393-6401
Web: www.alascience.com

ALA Scientific Instruments, Inc.
60 Marine Street
Farmingdale NY 11735